

Step Cam Switches, 1-2-3 With Zero, Type R, Door or Thru Panel Mounting



COMPLY WITH RULES

IEC 947-3, EN 60947-3, UL508

SERIES		P012-P016-P020 PX12-PX16-PX20			C025-C032-C040 CX25-CX32-CX40			C063-C080		G125		G200	
Protection class	control EN 60529 (UL50) NEMA 4X control with knob only terminals	IP65 (Type 1 - 4 -4X) IP40 IP20 (P0) - IP10 (PX)			IP65 (Type 1 - 4 -4X) IP40 IP20 (P0) - IP10 (PX)			IP65 IP40 IP00		IP65 - IP00		IP65 - IP00	
Material group	EN 60947-1	II			II			II		IIIA		IIIA	
Pollution grade	EN 60947-1	3			3			3		3		3	
Flammability	UL94	VO (Live Electrical parts)			VO (Live Electrical parts)			VO (Live Electrical parts)		VO (Live Electrical parts)		VO (Live Electrical parts)	
Ambient temperature	°C °C	Operating: -40 +85 Storage: -40 +70			Operating: -40 +85 Storage: -40 +70			Operating: -40 +70 Storage: -40 +70		Operating: -15 +55 Storage: -25 +70		Operating: -15 +55 Storage: -25 +70	
Climate Withstand	IEC 68 part 2-3 IEC 68 part 2-30	Hot damp Unsettled hot damp			Hot damp Unsettled hot damp			Hot damp Unsettled hot damp		- -		- -	
Terminal screw identification		EN50013			EN50013			EN50013		-		-	
Connections	Terminal block caliber EN60947-1 Terminal screw Screwing torque EN60947-1	A3 M3,5 0,8 Nm (7,2 lb. in.) 7,5 lb. in. (0,85 Nm)			A5 M4 1,2 Nm (10,6 lb. in.) 12 lb. in. (1,4 Nm)			A7 2xM4 1,2 Nm (10,6 lb. in.) 10,62 lb. in. (1,2 Nm)		Hex. screw M8 for bars and cable lugs		Hex. screw M10 for bars and cable lugs	
Connectable section	Flexible conductors min/max	mm ² AWG			1x0,75/4 - 2x0,75/2,5 10 - 18			2x2,5/10 14 - 6 2,5/35 14 - 3		-		-	
	Solid conductors min/max	mm ² AWG			1x0,75/4 - 2x0,75/2,5 10 - 18			2x2,5/10 14 - 6 2,5/35 14 - 3		-		-	
Contacts		Double breaking			Double breaking			Double breaking		Double breaking		Double breaking	
Opening angles		30° - 45° - 60° - 90°			30° - 45° - 60° - 90°			45° - 60° - 90°		60° - 90°		60° - 90°	
Mechanical lifetime at 120 operations for hour	mil./cl	1	1	1	1	1	1	1	1	0,1	0,1	0,1	0,1
Electrical lifetime at 120 operations for hour	mil./cl	1	0,75	0,75	1	0,75	0,75	0,5	0,25	0,01	0,01	0,01	0,01
CERTIFICATIONS		P012 PX12	P016 PX16	P020 PX20	C025 CX25	C032 CX32	C040 CX40	C063	C080	G125	G200		
CE	CE mark - Europe	■	■	■	■	■	■	■	■	■	■		
cUL	cUL Listed - USA and Canada	●	●	●	●	●	●	●	●	●	●		
IMQ	IMQ Istituto Marchio Qualità - Italy	●	●	●	●	●	●	●	●	●	●		
CCC	CCC Cina	●	●	●	●	●	●	●	●	●	●		
EAC	EAC Russia	●	●	●	●	●	●	●	●	●	●		

■ Comply to the requirements by passed test. ● Approved.

Step Cam Switches, 1-2-3 With Zero, Type R, Door or Thru Panel Mounting

EN 60947-3 CHARACTERISTICS			PO12 - PX12	PO16 - PX16	PO20 - PX20	CO25 - CX25	CO32 - CX32	CO40 - CX40	CO63	CO80	G125	G200
Rated operating voltage Ue	V		690	690	690	690	690	690	690	690	690	690
Rated insulation voltage Ui	V		690	690	690	690	690	690	690	690	690	690
Rated impulse withstand voltage Uimp (sectionable)	kV		4	4	4	6	6	6	8	8	6	6
Rated thermal current Ith	A		16	20	25	32	40	50	85	100	150	225
Rated thermal current in enclosed Ithe	A		12	16	20	25	32	40	85	100	150	225
Frequency	Hz		50/60	50/60	50/60	50/60	50/60	50/60	50/60	50/60	50/60	50/60
RATED OPERATING CURRENT Ie: alternate current			PO12 - PX12	PO16 - PX16	PO20 - PX20	CO25 - CX25	CO32 - CX32	CO40 - CX40	CO63	CO80	G125	G200
AC-21A Switching resistive loads with light overloads	690V	A	12	16	20	25	32	40	63	80	125	200
AC-22A Switching mixed resistive and inductive loads at light overloads	690V	A	12	16	20	25	32	40	63	80	125	200
AC-23A Periodic switching of motors	single phase - 1 pole	110V A/kW	12/1,1	14/1,5	18/2	25/1,5	30/2,2	35/3	45/4	63/5,5	-	-
		230V A/kW	12/2,2	14/3	18/4	25/4	30/5,5	35/6,5	45/7,5	63/11	-	-
	3 phases - 3 poles	230V A/kW	10/3	14/4	16/5	25/7,5	30/9	35/11	50/15	58/18,5	140/45	169/55
		400V A/kW	10/5,5	14/7,5	16/9	22/11	24/15	32/18,5	40/22	54/30	78/45 (415V)	95/55 (415V)
		500V A/kW	10/7,5	14/10	16/11	22/11	27/18,5	32/22	40/30	54/37	65/45	79/55
AC3 Starting of cage motors (interruption hile running)	single phase - 2 poles	110V A/kW	10/0,75	12/1,1	16/1,5	22/1,1	25/1,5	30/2,5	36/3,7	45/4	-	-
		230V A/kW	10/2	12/2,2	16/3,5	22/3,7	25/4	30/5,5	36/6,5	45/7,5	-	-
	3 phases - 3 poles	230V A/kW	8/2,2	10/3	12/4	18/5,5	23/7,5	27/9	37/11	47/15	115/37	140/45
		400V A/kW	8/4	10/5	12/6	18/7,5	23/11	27/15	35/18,5	44/22	64/37 (415V)	78/45 (415V)
		500V A/kW	8/5,5	10/7,5	12/8	18/11	23/15	27/18,5	35/22	44/30	53/37	64/45
Nominal interruption power AC-23A (cosφ 0,45)	230V	A	80	104	128	200	240	280	400	464	-	-
		A	80	104	128	176	216	256	320	432	-	-
		A	80	112	128	176	216	256	320	432	-	-
		A	80	112	128	160	176	200	256	320	-	-
Power dissipation for each pole	W	0,3*	0,35*	0,4*	-	-	-	-	-	-	-	
RATED OPERATING CURRENT Ie: direct current			PO12 - PX12	PO16 - PX16	PO20 - PX20	CO25 - CX25	CO32 - CX32	CO40 - CX40	CO63	CO80	G125	G200
DC-21A Switching resistive loads with light overloads	50V (1 phase)	A	10	12	16	20 ▼	25 ▼	32 ▼	-	-	-	-
DC-22A Switching mixed resistive and inductive loads at light overloads	30V (1 phase)	A	8	10	12	16 ▼	20 ▼	25 ▼	-	-	-	-
SHORT CIRCUIT CHARACTERISTICS			PO12 - PX12	PO16 - PX16	PO20 - PX20	CO25 - CX25	CO32 - CX32	CO40 - CX40	CO63	CO80	G125	G200
Rated short-time short circuit withstand current Icw (1 s)	A		300	300	300	500	500	500	1200	1200	-	-
Rated short circuit making capacity Icm	A		1200	1200	1200	2840	2840	2840	2000	2000	-	-
Conditional rated short circuit withstand current	kA		5	5	5	10	10	10	10	10	20	20
Fuse rating gG	690V	A	20	20	20	40 ■	40 ■	40 ■	100	100	125 ▲	200 ▲
UL 508 CHARACTERISTICS			PO12 - PX12	PO16 - PX16	PO20 - PX20	CO25 - CX25	CO32 - CX32	CO40 - CX40	CO63	CO80	G125	G200
General Use	600V AC	A	12	16	20	25	32	40	63	85	125	175
Standard motor load	single phase - 2 poles	120V AC HP (FLA)	0,5 (9,8)	1 (16)	1,5 (20)	1,5 (20)	2 (24)	3 (34)	5 (56)	5 (56)	-	-
		240V AC HP (FLA)	1 (8)	1,5 (10)	2 (12)	3 (17)	5 (28)	5 (28)	7,5 (40)	10 (50)	-	-
	3 phases - 3 poles	200V AC HP (FLA)	1,5 (6,9)	3 (11,04)	5 (17,5)	7,5 (25,3)	7,5 (25,3)	10 (32,2)	-	-	10 (56)	15 (84)
		240V AC HP (FLA)	3 (9,6)	5 (15,2)	5 (15,2)	7,5 (22)	7,5 (22)	10 (28)	15 (42)	20 (54)	20 (54)	25 (68)
		480V AC HP (FLA)	5 (7,6)	7,5 (11)	10 (14)	15 (21)	20 (27)	20 (27)	30 (40)	40 (52)	40 (52)	50 (65)
		600V AC HP (FLA)	5 (6,1)	7,5 (9)	10 (11)	15 (17)	20 (22)	20 (22)	40 (41)	50 (52)	50 (52)	50 (52)

▼ Values not reported on the IMQ files. ■ Fuses type gG 40a 500V ▲ Fuses type gG/Gm

Step Cam Switches, 1-2-3 With Zero, Type R, Door or Thru Panel Mounting

| RANGE AC21A | 12A - 16A - 20A |

SCREW FIXING

Ø22 FIXING

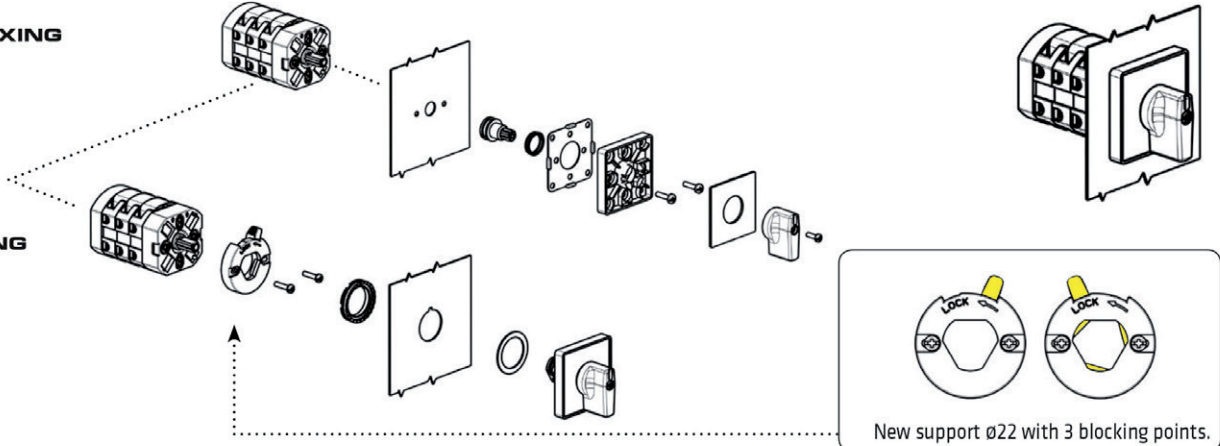

| RANGE AC21A | 25A - 32A - 40A |

SCREW FIXING

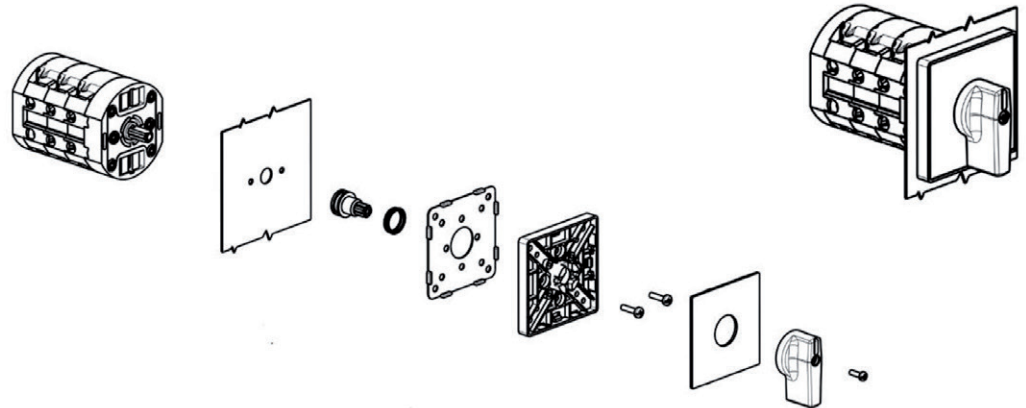

| RANGE AC21A | 63A - 80A |

SCREW FIXING

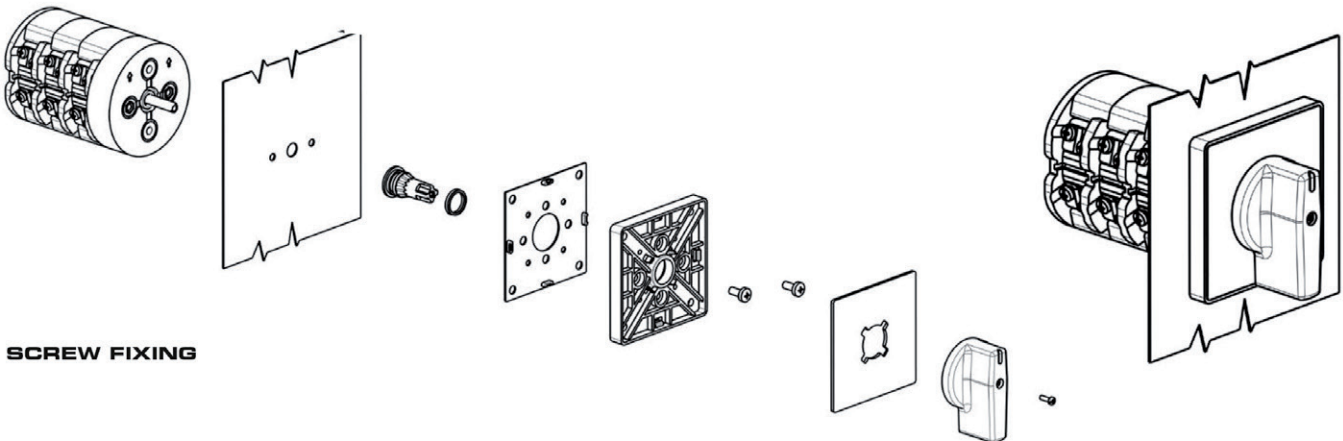

| RANGE AC21A | 125A |

SCREW FIXING

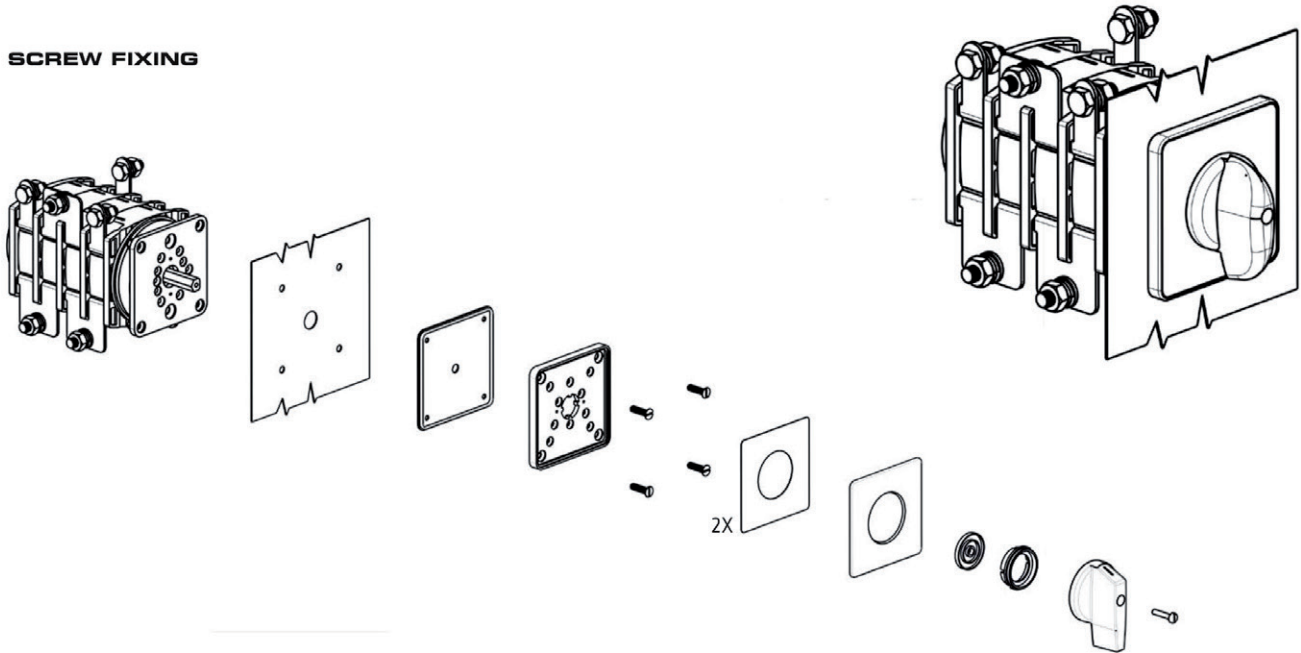

| RANGE AC21A | 200A |

SCREW FIXING

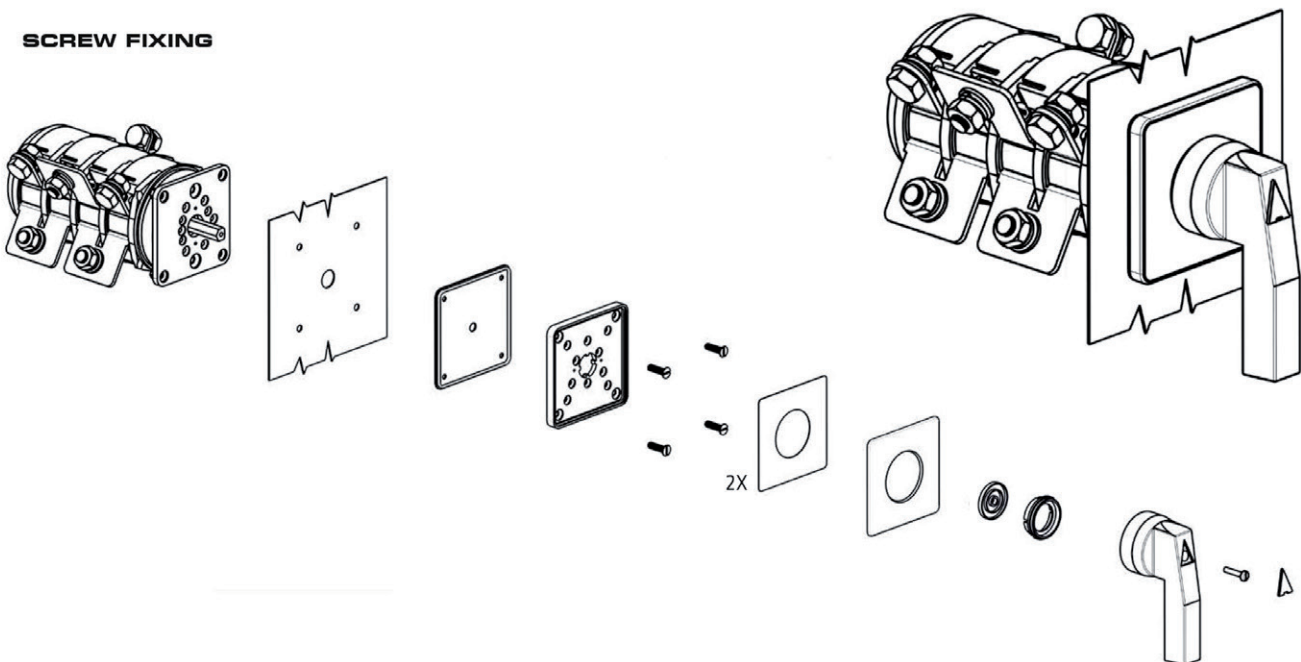



12-16-20A



45°



90°
G125
G200



25-32-40A

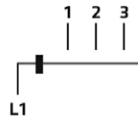

45°



90°
G125
G200

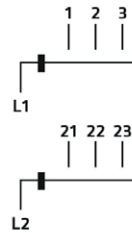

45°



90°
G125
G200

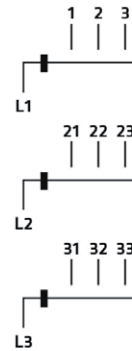

125A

2	7-8			X	
	5-6	X			
1	1-2		X		
WV	CONT.	0	1	2	3

3	11-12			X	
	9-10	X			
2	7-8		X		
	5-6		X		
1	3-4			X	
	1-2	X			
WV	CONT.	0	1	2	3















5	19-20			X	
4	15-16			X	
	13-14	X			
3	11-12			X	
	9-10	X			
2	7-8		X		
	5-6		X		
1	3-4			X	
	1-2	X			
WV	CONT.	0	1	2	3



200A

SERIES	AC21A	1 POLE	2 POLES	3 POLES
P012	12A	P0120029R	P0120034R	P0120035R
P016	16A	P0160029R	P0160034R	P0160035R
P020	20A	P0200029R	P0200034R	P0200035R
C025	25A	C0250029R	C0250034R	C0250035R
C032	32A	C0320029R	C0320034R	C0320035R
C040	40A	C0400029R	C0400034R	C0400035R
C063	63A	-	-	-
C080	80A	-	-	-
G125	125A	G1250029R	G1250034R	G1250035R
G200	200A	G2000029R	G2000034R	G2000035R

Step Cam Switches, 1-2-3 With Zero, Type R, Door or Thru Panel Mounting

ACTUATOR	FIXING	P012 · P016 · P020		C025 C032 C040	C063 C080	G125	G200
		 45°	 NO	 45°	-	 90°	 90°
	screw ø22	001/0029 056X/0029	- -	007/0029 -	- -	441/0029 -	461/0029 -
	screw ø22	- -	- -	- -	- -	- -	- -
	screw ø22	- -	- -	- -	- -	- -	- -
	screw ø22	- -	- -	- -	- -	- -	- -
	screw ø22	- -	- -	- -	- -	- -	- -
	screw ø22	- -	- -	- -	- -	- -	- -
	ø22	-	-	-	-	-	-
	ø22	-	028X	-	-	-	-
	ø22	-	029X	-	-	-	-

 Key removable at 0° and 180°

Step Cam Switches, 1-2-3 With Zero, Type R, Door or Thru Panel Mounting



12-16-20A

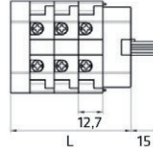
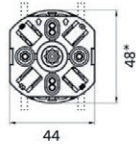

WAFER GAP	L x WAFER N°					
	1	2	3	4	5	6
12,7	37,4	50,1	62,8	75,5	88,2	100,9

* If cam switch is provided of external bridge (wafer to wafer) the height will be increased of ~ 2 mm for the lower and upper sides.



25-32-40A

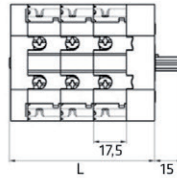
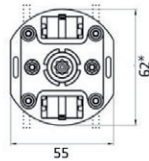

WAFER GAP	L x WAFER N°					
	1	2	3	4	5	6
17,5	42,2	59,7	77,2	94,7	112,2	129,7

* If cam switch is provided of external bridge (wafer to wafer) the height will be increased of ~ 1 mm for the lower and upper sides.



63-80A

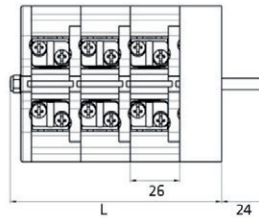
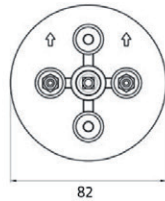

WAFER GAP	L x WAFER N°					
	1	2	3	4	5	6
26	59,1	85,1	111,1	137,1	163	189,1



125A

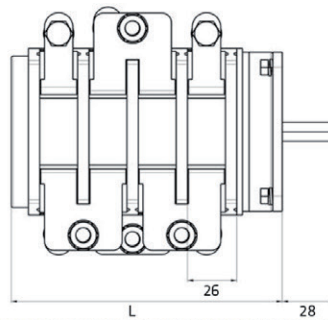
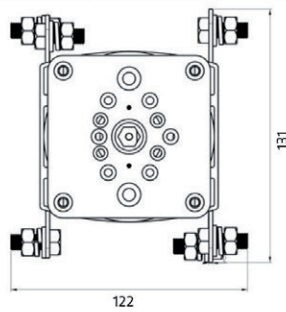

WAFER GAP	L x WAFER N°					
	1	2	3	4	5	6
26	66	92	118	144	170	196



200A

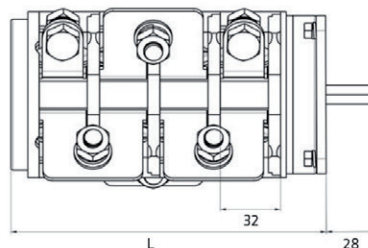
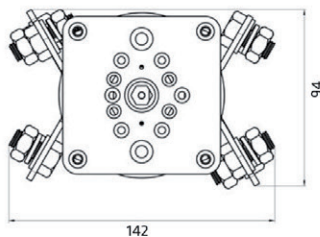

WAFER GAP	L x WAFER N°					
	1	2	3	4	5	6
32	72	104	136	168	200	232

Step Cam Switches, 1-2-3 With Zero, Type R, Door or Thru Panel Mounting

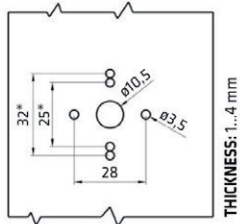

THICKNESS: 1...4 mm

FIXING:
Captive M3 bolt - 28 mm
* ALTERNATIVE FIXING
Screwplast 25 or 32 mm

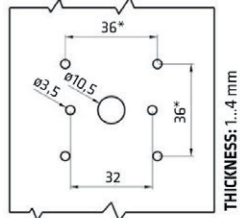
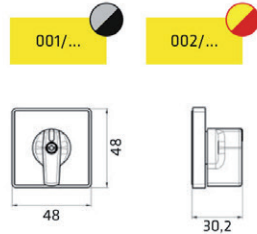

THICKNESS: 1...4 mm

FIXING:
Captive M3 bolt - 32 mm
* ALTERNATIVE FIXING
Screwplast 36 mm

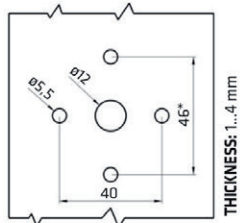
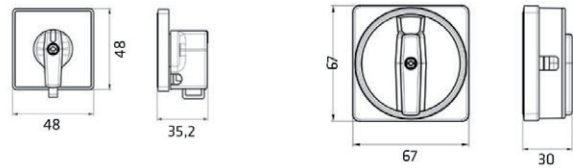
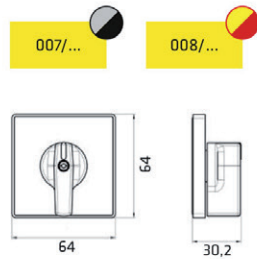

THICKNESS: 1...4 mm

FIXING:
Captive M5 bolt - 40 mm
* ALTERNATIVE FIXING
M5 - 46 mm

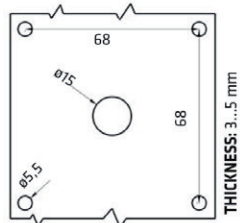
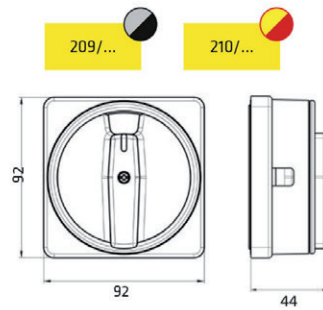
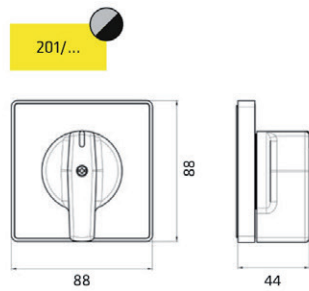

THICKNESS: 3...5 mm

FISSAGGIO:
M5 bolt 68 mm

